

Kitchen Installation Manual



HOWDENS
JOINERY CO.

MAKING SPACE MORE VALUABLE

June 2018

Section pages

Introduction	page 4
Supplied products	page 4
Guide - Hints and tips	page 5
Cabinet installation fittings	page 6
Additional installation fittings in pack	page 7
Planning dimensions	
Standard cabinets	page 8
Deep wall cabinets	page 9
Profile kitchens	page 10
Profile kitchens - Larder	page 11
Cabinet corner - Standard wall	page 12
Cabinet corner - Deep wall	page 13

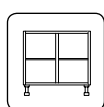

Section 1:

Kitchen installation - base cabinets	page 15
--	---------



Section 2:

Profile kitchens	page 35
------------------------	---------

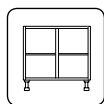

Section 3:

Linear Look	page 53
-------------------	---------

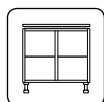

Section 4:

Kitchen installation (excluding base cabinets)	page 59
--	---------

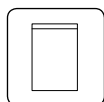

Section 5:

Integrated handle design kitchen	page 111
--	----------

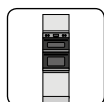

Section 6:

Appliance tower shelf configurations	page 121
Bosch washing machine installation	page 169
Bosch washer dryer installation	page 170

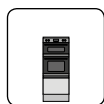

Section 7:

Midi-tower shelf configurations	page 175
---------------------------------------	----------

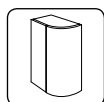

Section 8:

Curved units	page 193
--------------------	----------

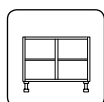

Section 9:

Inclusive kitchens	page 201
--------------------------	----------

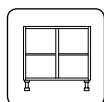

Section 10:

Contract kitchens	page 211
-------------------------	----------

Index	page 214
-------------	----------

Introduction

This manual has been produced to give information on how to effectively install a Howdens Joinery kitchen. It contains not only installation information, but also assembly details on some products and components such as drawer boxes, corner base cabinets and other specific items.

The manual is a complete guide to the assembly and installation of the kitchen and we would encourage you to keep this for reference when installing Howdens Joinery kitchens in the future. Your Howdens depot will be able to advise you on any installation queries you may have, but please refer to this manual in the first instance.

Whilst you may have installed many kitchens in the past, please ensure you are familiar with the basics of installation before starting the build.

One main point to note is the new Linear style of kitchen which can be created using new and existing components. Please refer to the linear **section 3**.

Howdens has also has a profile system enabling the opening of the slab doors and drawers whilst maintaining the clean lines and linear look of the handle-less frontal. The profiles are simple to fit and are covered in **section 2**.

The profiles secure to the front of the base cabinets and the sides of the cabinets in larder/appliance tower applications.

Profiles are supplied in specific lengths and should be cut down to the appropriate size to fit to the cabinet run. The planning section of this manual shows examples of the different profile applications and the principles for installation which can be applied to your cabinets. It also covers the profile packs and fittings provided with them.

Supplied products

Cabinets are supplied with a fittings pack which contains the fittings required for installation. **NOTE:** There may be some additional items in the pack such as worktop fixing brackets which will not be required for this handle-less kitchen installation.

Profiles for the various applications are packaged separately and are supplied with the fittings required for installation.

Appliance towers are supplied in a standard format and will require modification depending on the appliance you're using. Follow the appliance tower section of the manual for the different configurations and adjust the cabinet accordingly.

If you are installing a solid timber or solid surface worktop (such as granite), please refer to the separate installation instructions for these worktop types which are available from the Howdens Joinery Depot.



Recycle packaging in a safe environmentally friendly way.



Choking hazard, keep away from young children.



Panels can be multi-drilled, use only correct hole location.



Protective eye wear required.



Beware of sharp edges on profiles.

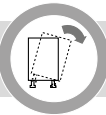

Secure to wall (additional fittings may be required).

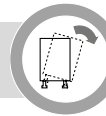

Secure to wall (additional fittings may be required).



PROFILE KITCHENS ONLY

GENERAL NOTES:

- If fitting plinth drawers to base cabinet, these must be fitted before cabinet installation.
- The appliance tower back panel must be removed from the cabinet before installing an appliance. The back panel is only required behind a cupboard area, as the aperture for the appliance must not be enclosed due to ventilation.
- When adjusting the feet on base cabinets, ensure the thread is not extended too high.
- When routing laminate worktops, care should be taken not to burn the laminate. Always ensure the tooling is not blunt and the wheel bearings are moving freely.
- When cutting profiles, ensure tooling is not blunt so as not to damage profile.

Guide - Hints and tips



Installation should start in a corner, working out along the walls. Base cabinets should be installed first, followed by tower cabinets and finally wall cabinets. Worktops, doors, door handles, drawer fronts, plinths, pelmets and cornice are best fitted at the end of the installation.



Whilst the room is empty, check the position of the plumbing and electrical points.

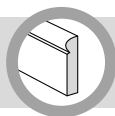

You may need to remove skirting boards along the length/walls of the cabinets for some installations.

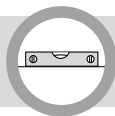

It is important that all cabinets are installed both plumb and level before starting.



Be aware of concealed plumbing and electrical wiring when drilling into walls.

IMPORTANT:

Before fixing any cabinets to the wall, ensure the construction of that wall is capable of taking the weight of the loaded cabinet and the appropriate fixings are used. If in any doubt, please consult a professional.

IMPORTANT:

When fitting granite or quartz worktops, a metal bar should be fitted to support any unsupported spans. This may be where an appliance has been fitted between cabinets, where a gap has been left in a breakfast bar application or where the cabinet front support rail has been cut to accommodate a sink or hob. The metal bar can be fitted directly under the profile, or under the MDF worktop support rail where applicable. Please refer to the granite/quartz installation guides for details of the metal support bars and fitting method.

Glue:

When using PVA wood glue, wipe away excess glue with a clean damp cloth.

NOTE: EXCESSIVE USE OF GLUE IN PANEL HOLES MAY CAUSE SPLITTING.

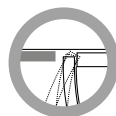

IMPORTANT: When tiling up to the curved wall cabinet, ensure sufficient gap is left to enable the door to open correctly.



Ensure this installation manual is retained for future use.

NOTE: During transit, standard and deep wall cabinet shelves have been secured in the base of the cabinet with retaining clips. Before installation, remove the shelves from the cabinet by removing the clips. These clips can be discarded. Shelf pegs have been supplied in a separate fittings pack.

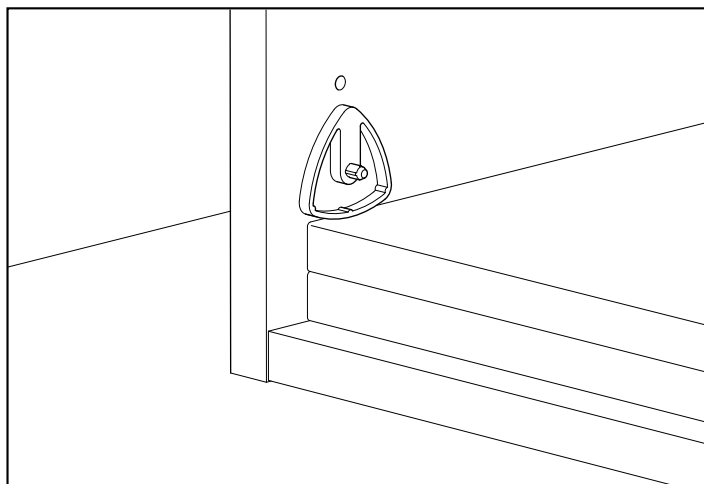
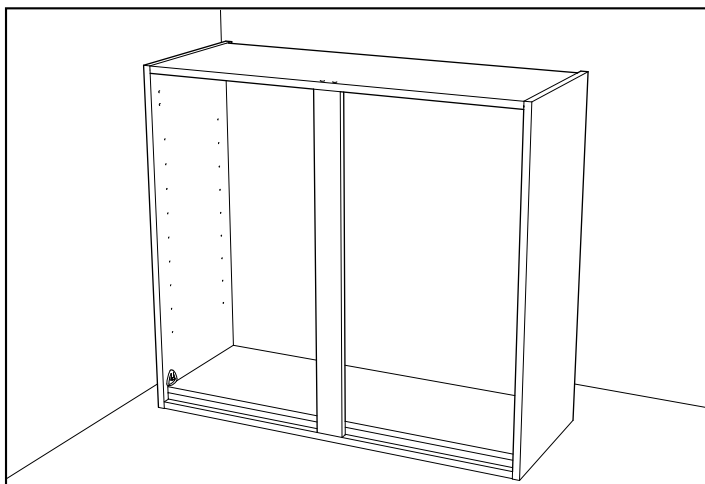

Cabinet installation fittings

The fittings shown on these pages are standard fittings that may have been supplied with the cabinet pack for installation. Other fittings may be shown in this manual for specific cabinet types. These will be referenced at the appropriate stages.

NOTE: Wall fixing screws have not been supplied due to different wall types requiring different fixings.

Wall and base cabinets

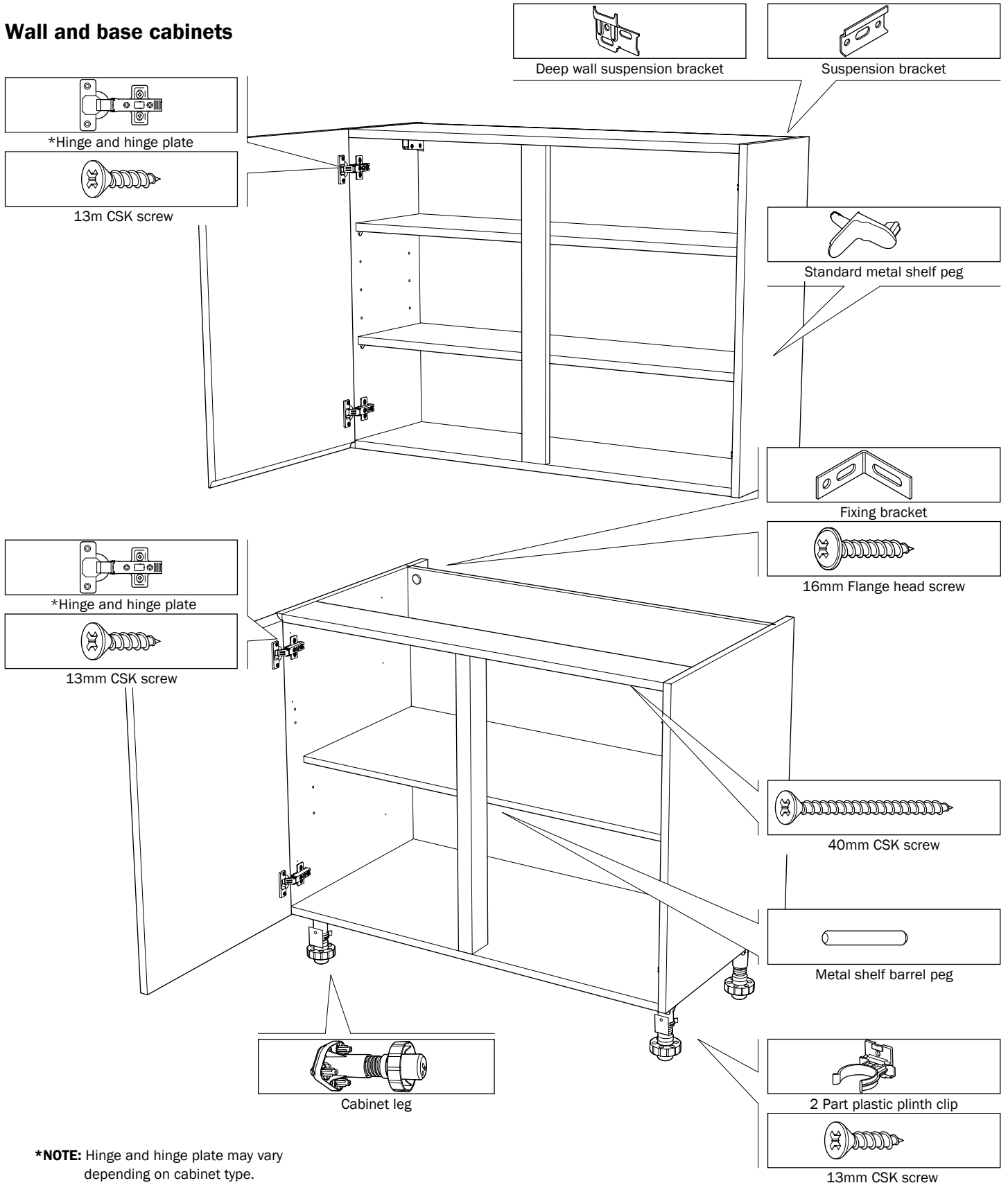

***NOTE:** Hinge and hinge plate may vary depending on cabinet type.

Additional installation fittings in pack

Screws and fixings

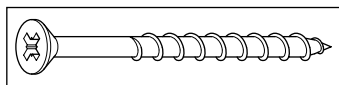

45mm or 50mm CSK screw

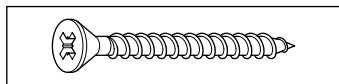

30mm CSK screw

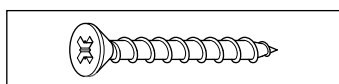

25mm CSK screw

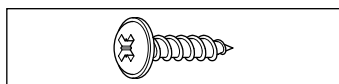

13mm Flange head screw

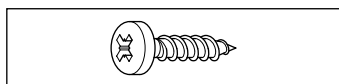

12mm Pan head screw

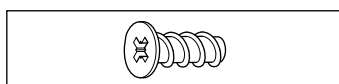

EURO screw

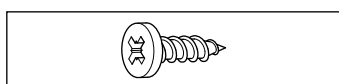

14mm screw

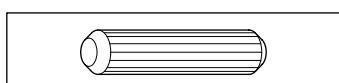

6 x 22 Wooden dowel

Deep wall cabinet shelf fixings

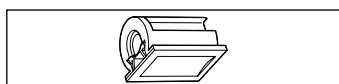

Concealed shelf peg housing

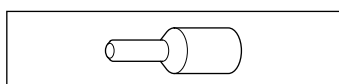

Concealed shelf peg

Hinges

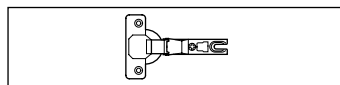

110° Kitchen hinge

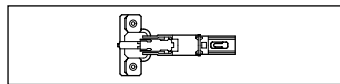

170° Kitchen hinge

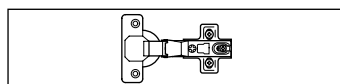

Slimline hinge

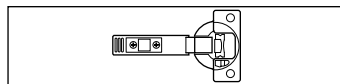

Integrated soft close hinge

Brackets and joints



90° Die cast bracket

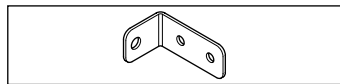

Larder bracket

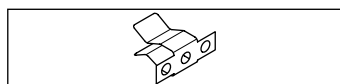

Spring clip - Female

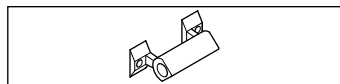

Spring clip - Male

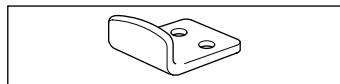

Stable door stop

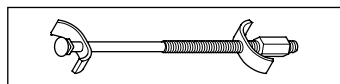

Worktop connector bolts

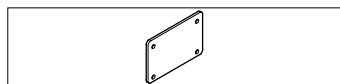

Steel jointing plate

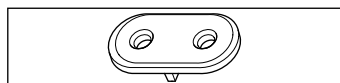

Steel jointing plate



Long steel jointing plate

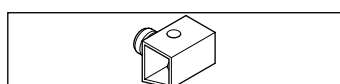

Worktop fixing bracket

Caps

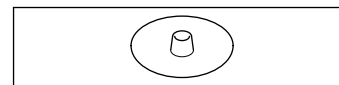

Screw cover cap

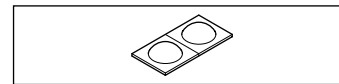

Bumpers (x2)

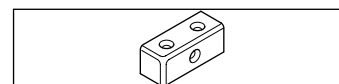

KD block

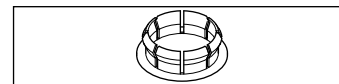

Hinge hole cover cap

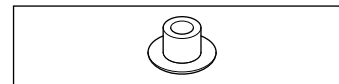

5mm Cover cap

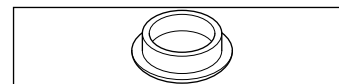

Corner cover cap

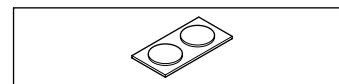

Self-adhesive cover cap

Planning dimensions - Standard cabinets

CONSIDERATIONS

- Use **25mm screws** for **12mm decor ends**.

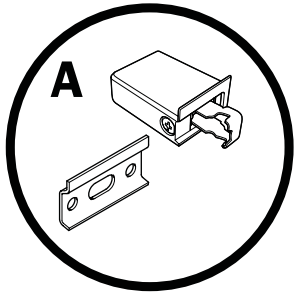

Wall hanging brackets

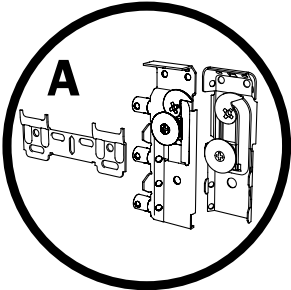

Concealed wall hanging bracket (deep wall only)

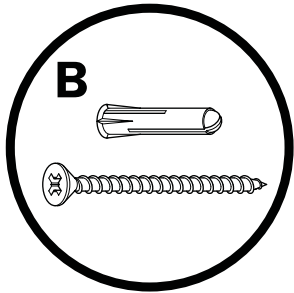

Wall fixings

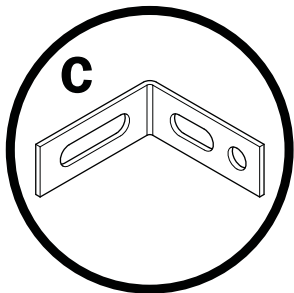

Base cabinet fixing bracket

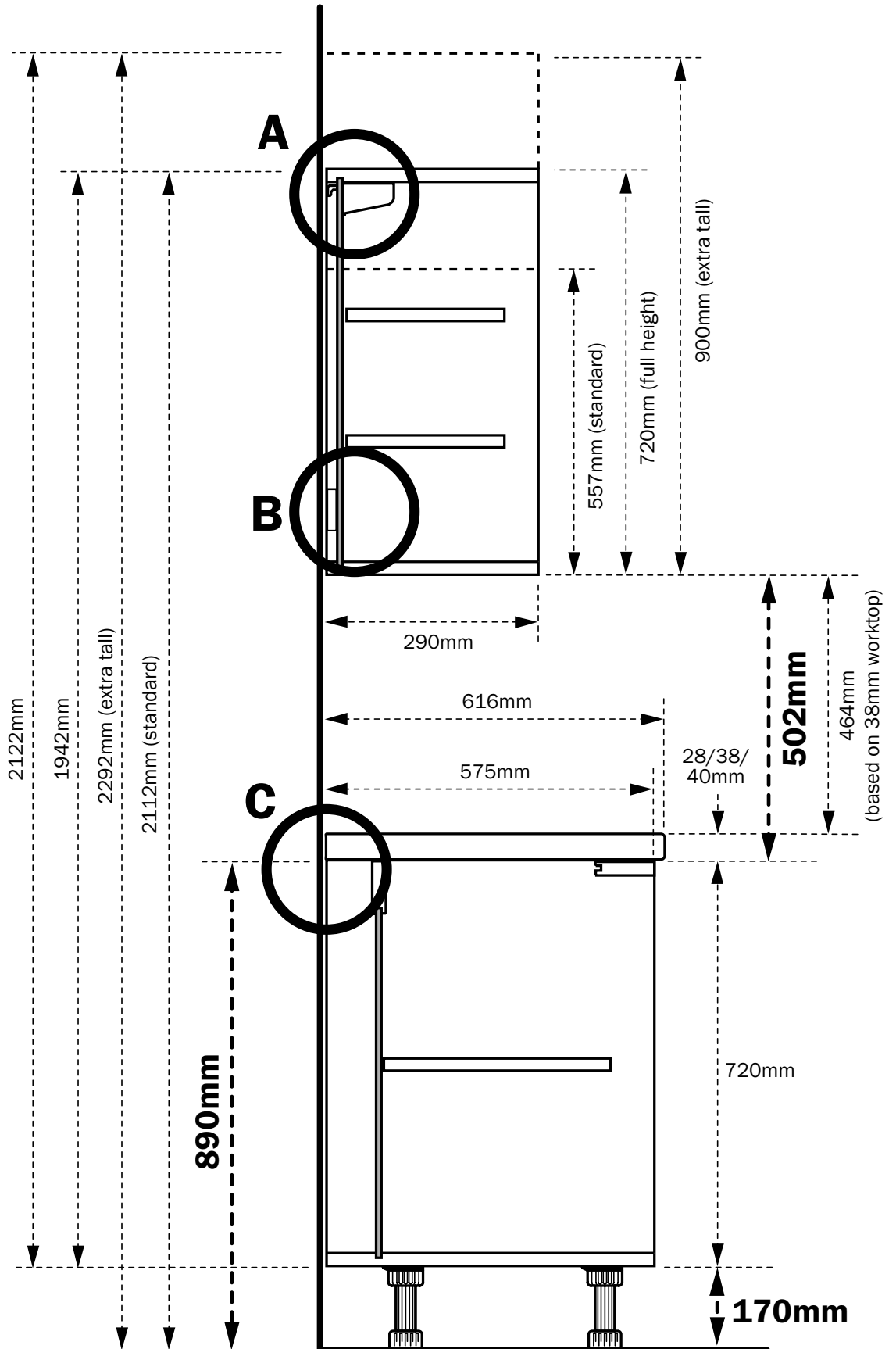

Planning dimensions - Deep wall cabinets

CONSIDERATIONS

- Use **25mm screws** for **12mm decor ends**.

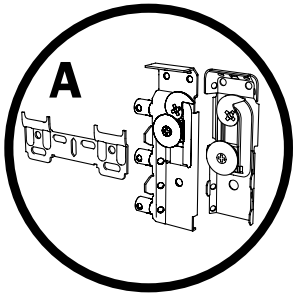

Concealed wall hanging brackets

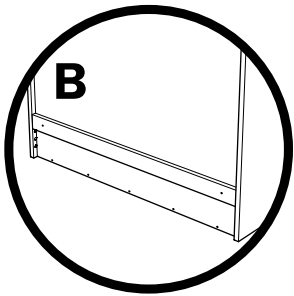

Wall fixing back rail

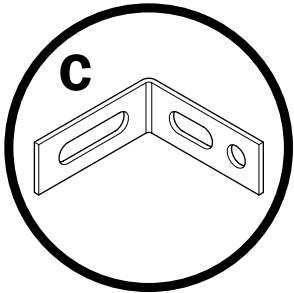

Base cabinet fixing bracket

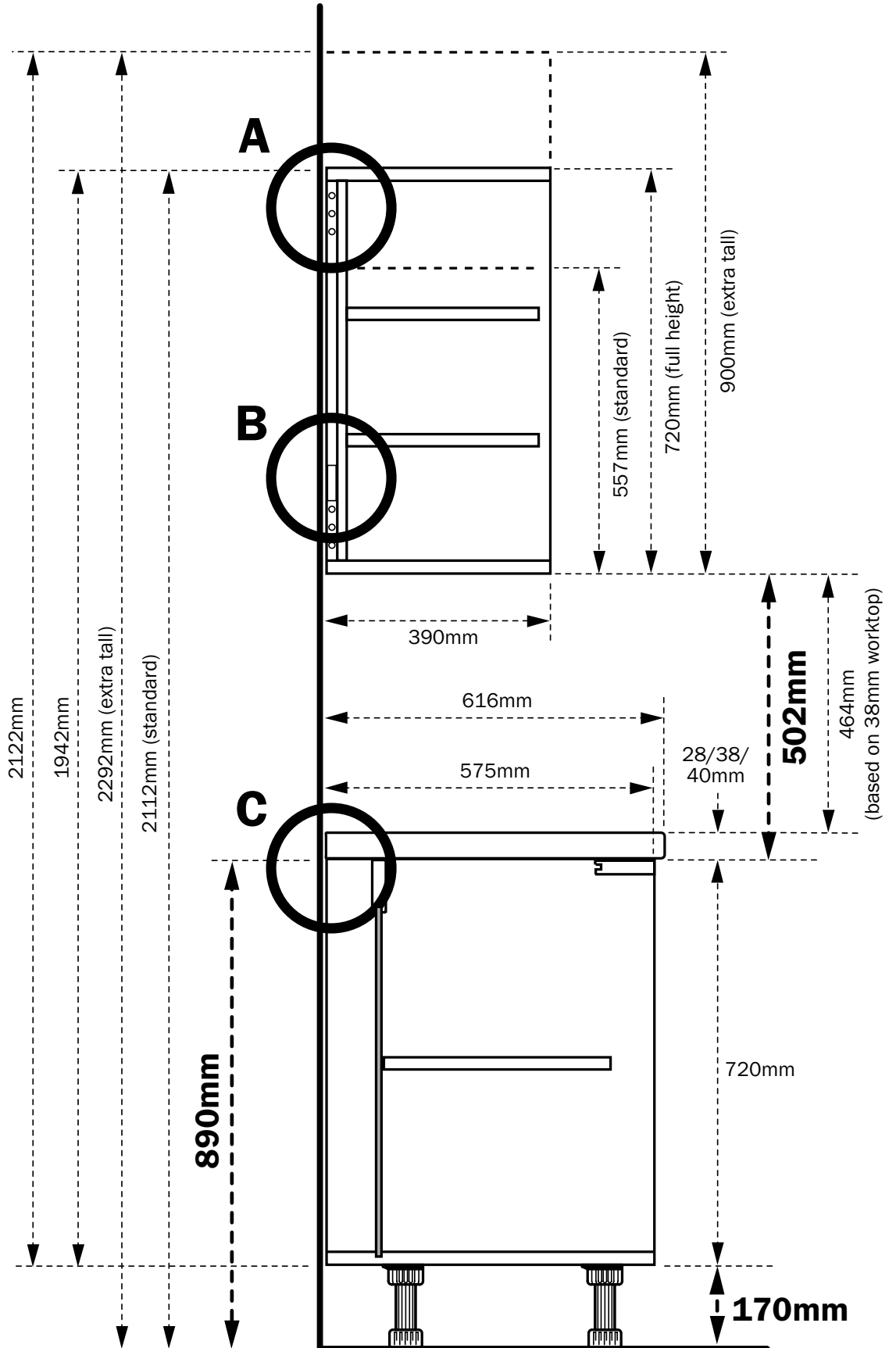

Planning dimensions - Profile kitchens

CONSIDERATIONS

- Worktop height is elevated by 30mm due to the profile application compared to other kitchen ranges.
- Tower/larder applications require a 30mm spacing each side to allow for the profile fitting.
- Pelmet rail should not be used on this handle-less style kitchen range.
- Appliance/larder towers are left and right handed depending on the door opening preference.
- When fitting two half height cabinets on top of each other, the top opening door will require a magnetic catch – push to open.
- Use **25mm screws** for **12mm decor ends**.

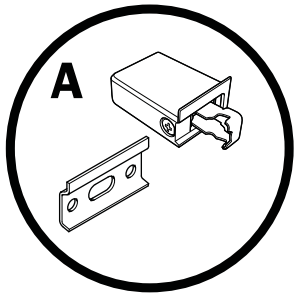

Wall hanging brackets

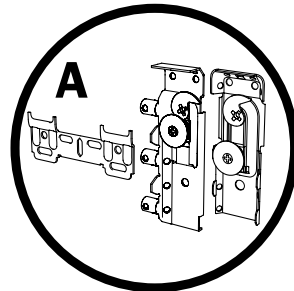

Concealed wall hanging bracket (deep wall only)

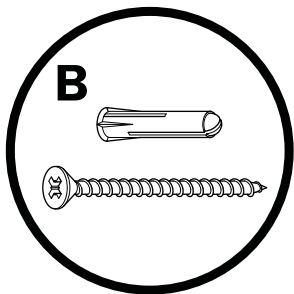

Wall fixings

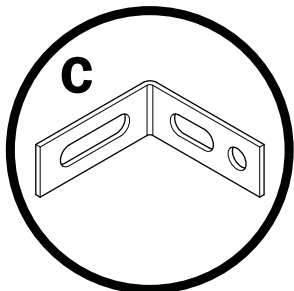

Base cabinet fixing bracket

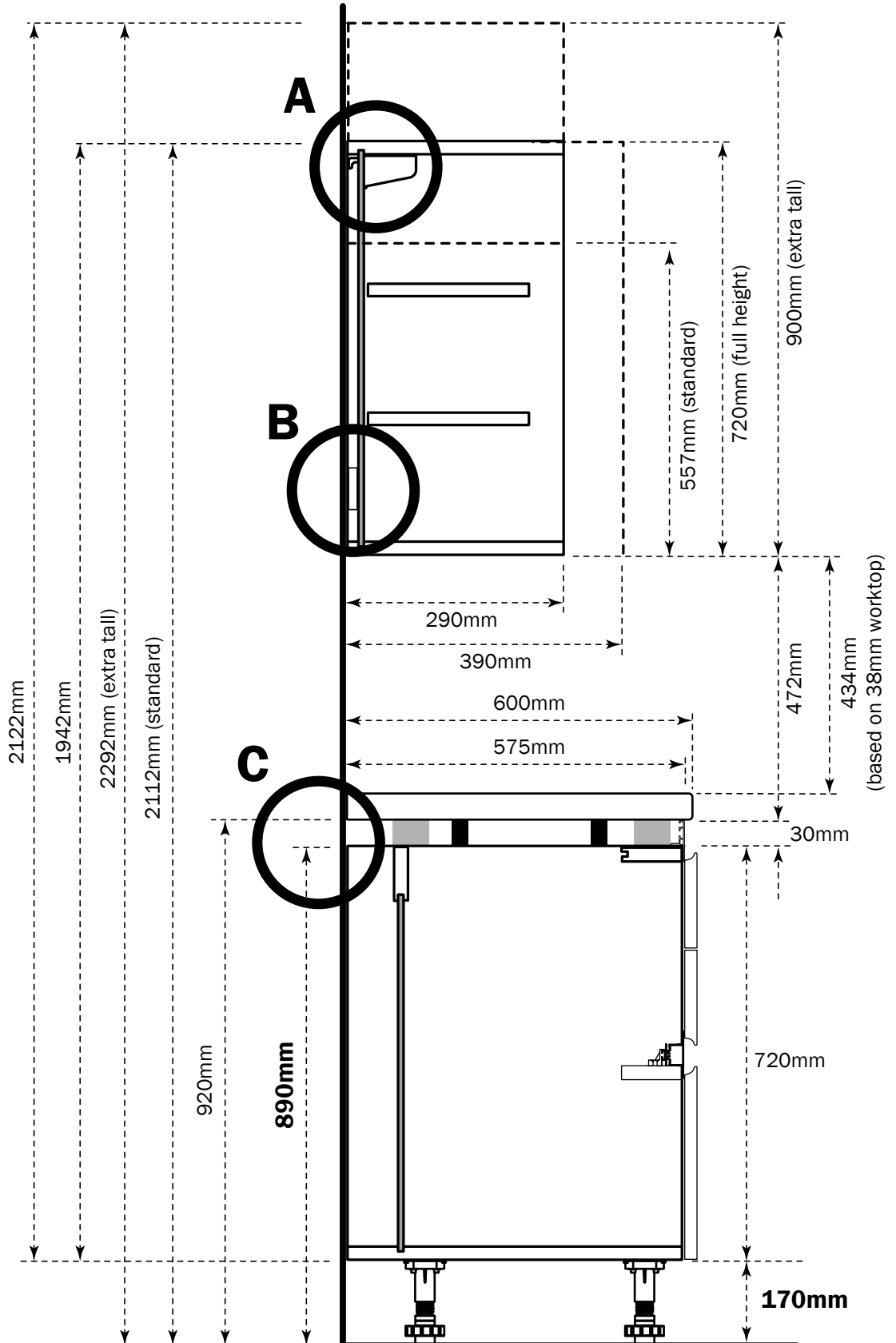



Planning dimensions - Larder

End and mid larder profiles Important fitting information

Ensure cabinets are perfectly aligned and level before fitting profiles.

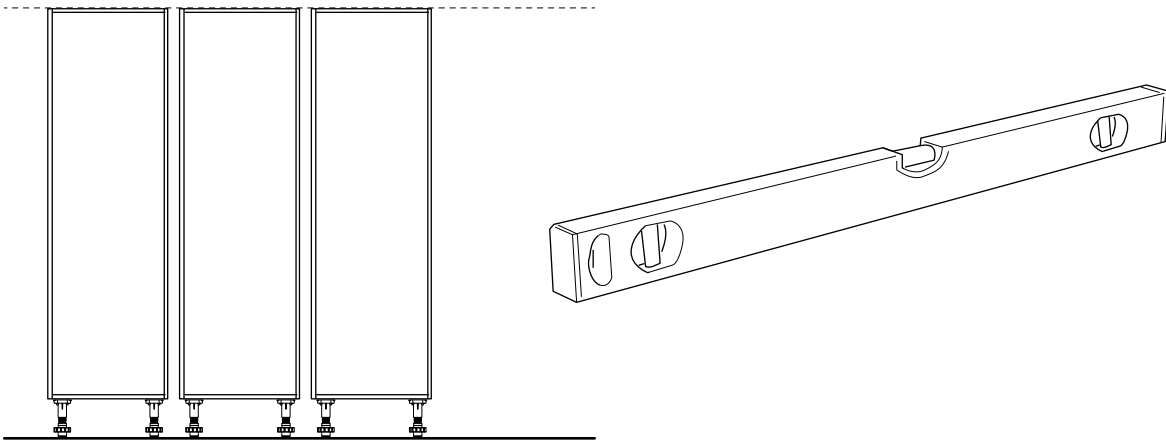

Profiles must be fitted flush with the top edge of the cabinet end panels.

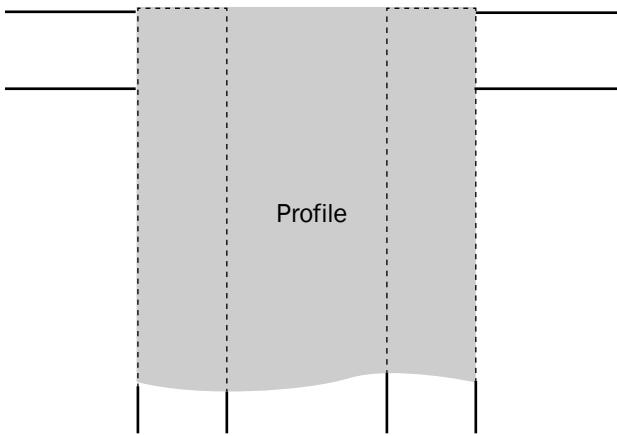

Fit the top door first so it is flush with the top edge of the profile.

NOTE: If you have a low ceiling height which is touching the top of the profile, adjust the door down 2mm to give clearance.

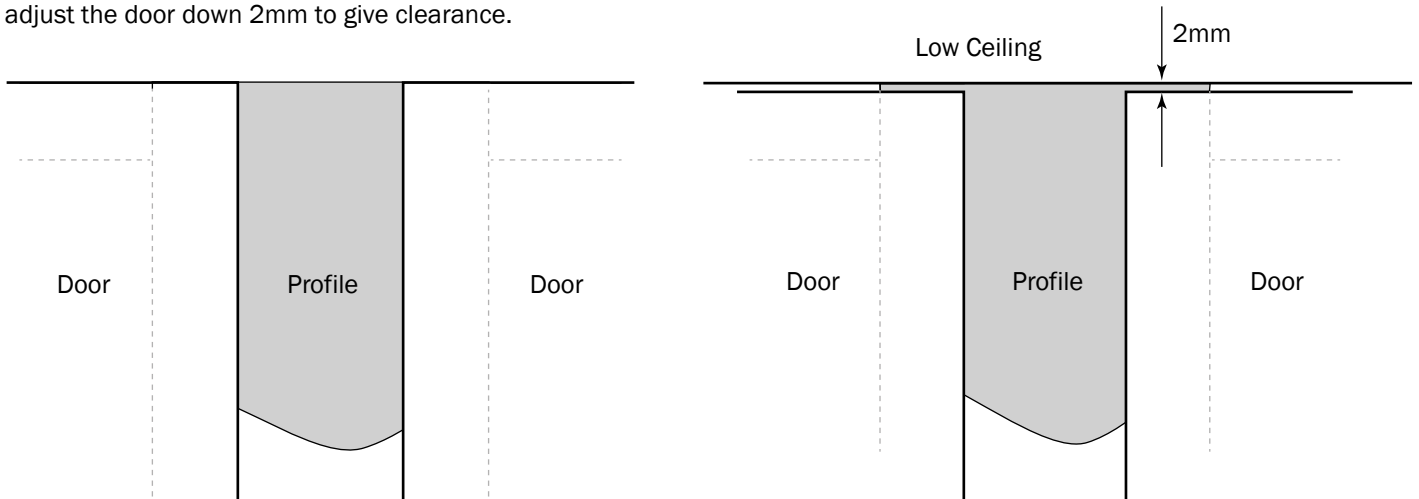

Planning dimensions - Cabinet corner

Standard wall cabinet

Always plan your kitchen/start the installation from a corner.

Movable centre uprights are fitted to the cabinets to give flexibility to the configurations.

Ensure consideration is given to cabinet alignment and lighting.

NOTE: 600mm corner wall and adjacent cabinet can be replaced using a 631 L shaper wall as required.

931 Corner

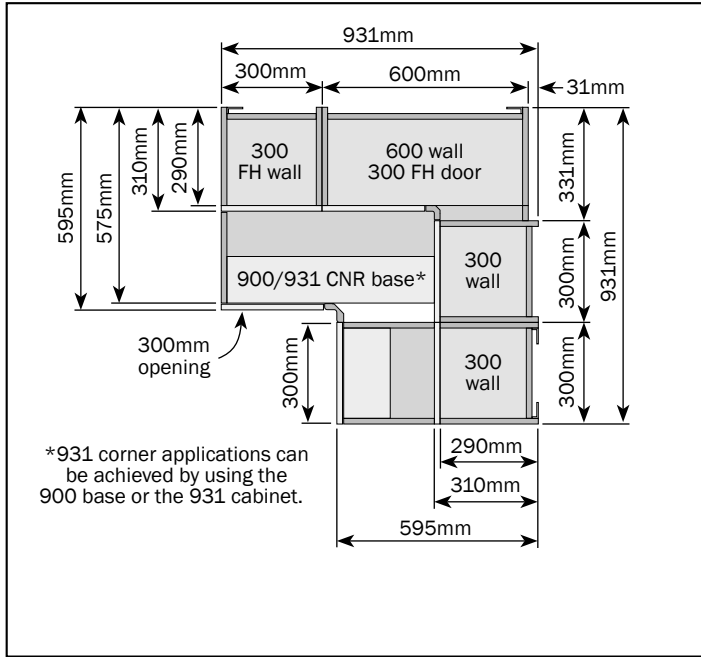

1031 Corner

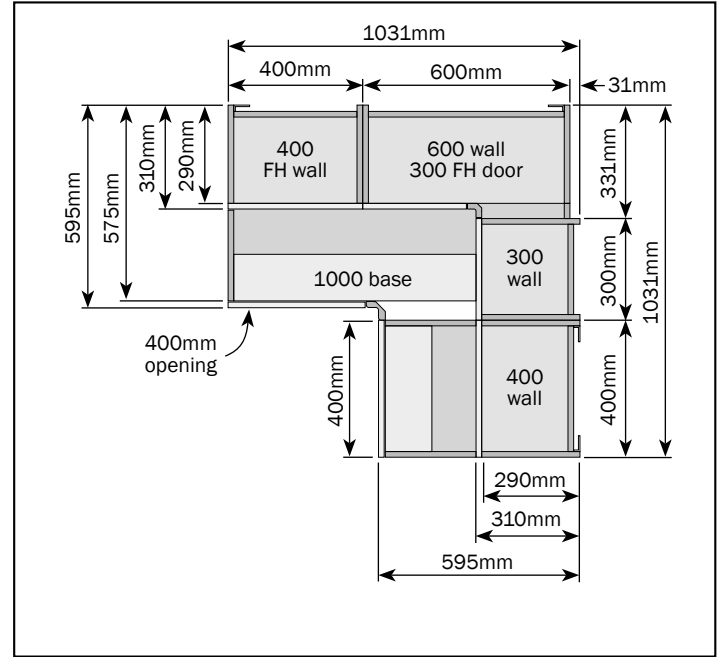

1131 Corner

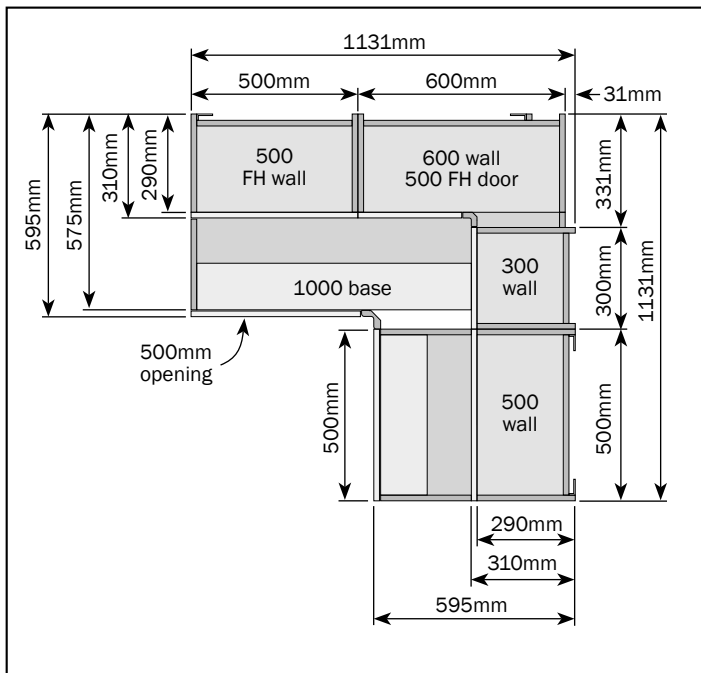

1231 Corner

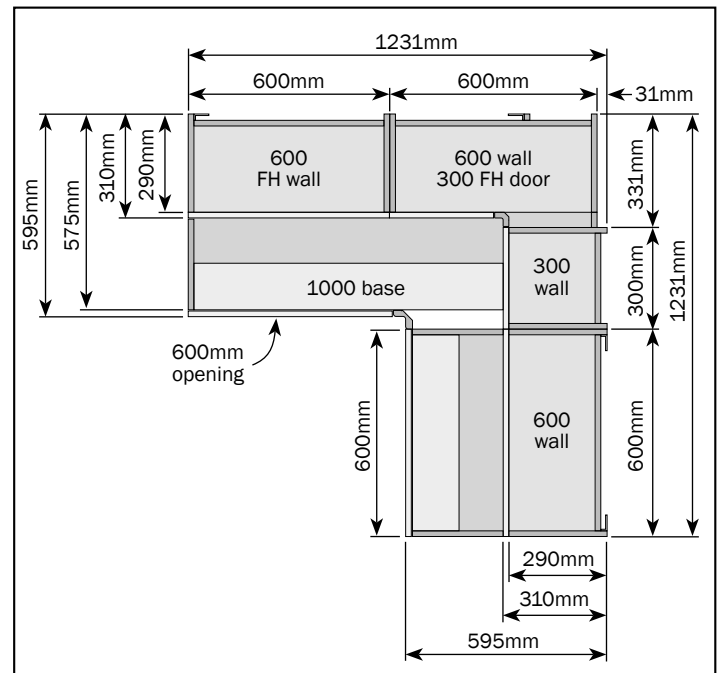

Planning dimensions - Cabinet corner

Deep wall cabinet

Always plan your kitchen/start the installation from a corner.

Movable centre uprights are fitted to the cabinets to give flexibility to the configurations.

Ensure consideration is given to cabinet alignment and lighting.

NOTE: 700mm corner wall and adjacent cabinet can be replaced using a 731 L shaper wall as required.

931 Corner

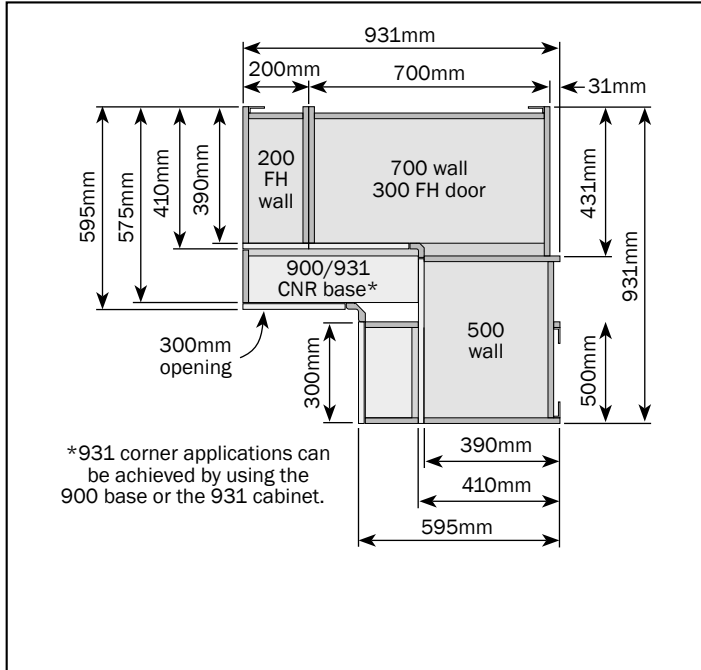

1031 Corner

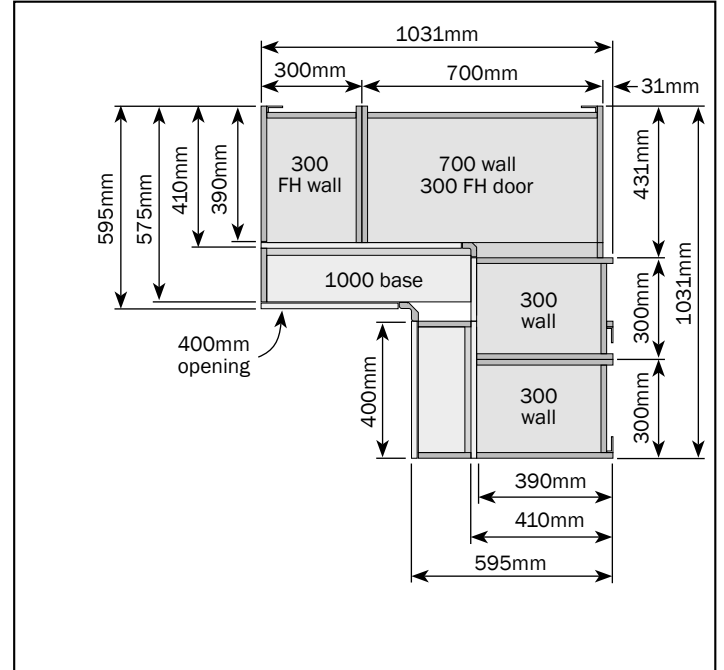

1131 Corner

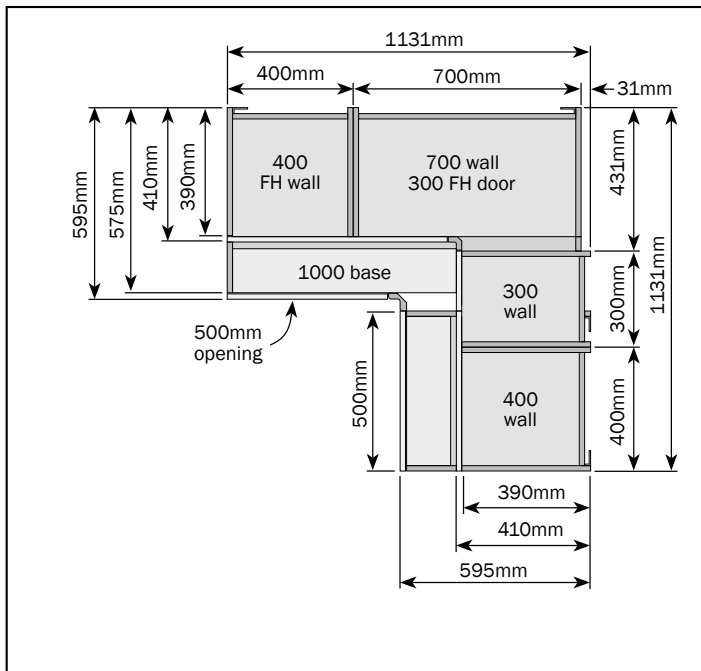

1231 Corner

